

Capacitor Switching -Contactors 2



Contactors 3



Auxiliary Contact Blocks 3



Technical Data 4, 5, 6

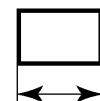

Dimensions 7

Typical Circuit Diagram 8

Contactor operation 8

Function 9,10,11

# Capacitor Switching Contactors

for use with reactive or non-reactive capacitor banks

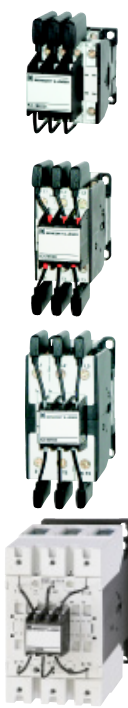

Rated Operational Power at 50/60Hz						Aux. Contacts		Type	Coil voltage <sup>1)</sup> 220-240V 50Hz	Pack pcs.	Weight kg/pc.	
Ambient Temperature						Built-in Add.						
50°C			60°C			NO	NC	230	↓			
380V	415V	660V	380V	415V	660V	1	1					
400V	440V	690V	400V	440V	690V							
kVA	kVA	kVA	kVA	kVA	kVA							
0-12,5	0-13	0-20	0-12,5	0-13	0-20	1	-	1 <sup>2)</sup>	<b>K3-18K10</b>	...	1	0,34
0-12,5	0-13	0-20	0-12,5	0-13	0-20	-	1	1 <sup>2)</sup>	<b>K3-18K01</b>	...	1	0,34
10-20	10,5-22	17-33	10-20	10,5-22	17-33	-	-	3 <sup>3)</sup>	<b>K3-24K00</b>	...	1	0,62
10-25	10,5-27	17-41	10-25	10,5-27	17-41	-	-	3 <sup>3)</sup>	<b>K3-32K00</b>	...	1	0,62
20-33,3	23-36	36-55	20-33,3	23-36	36-55	-	-	3 <sup>3)</sup>	<b>K3-50K00</b>	...	1	1,0
20-50	23-53	36-82	20-50	23-53	36-82				<b>K3-62K00</b>	...		
20-75 <sup>4)</sup>	23-75 <sup>4)</sup>	36-120 <sup>4)</sup>	20-60	23-64	36-100				<b>K3-74K00</b>	...		
33-80	36-82	57-120	33-75	36-77	57-120	-	-	6 <sup>5)</sup>	<b>K3-90K00</b>	...	1	2,3
33-100 <sup>6)</sup>	36-103 <sup>6)</sup>	57-148 <sup>6)</sup>	33-90 <sup>6)</sup>	36-93 <sup>6)</sup>	57-148 <sup>6)</sup>	-	-	6 <sup>5)</sup>	<b>K3-115K00</b>	...	1	2,3

**Specification:** Contactors K3...K are suitable for switching low-inductive and low loss capacitors in capacitor banks (IEC70 and 831, VDE 0560) without and with reactors.

Capacitor switching contactors are fitted with early make contacts and damping resistors, to reduce the value of make current <math>< 70 \times I\_e</math>.

**Operating Conditions:** Capacitor switching contactors are protected against contact welding for a prospective making current of  $200 \times I_e$ .

**Mounting instructions:**

In the area of capacitor switching contactors, difficulty inflammable and self-extinguishing materials shall be used only, because abnormal temperatures within the area of the resistor spirals cannot be excluded.





**Technical Data** acc. to IEC 947-4-1, IEC 947-5-1, EN 60947-4-1, EN 60947-5-1, VDE 0660

Type		K3-18K	K3-24K	K3-32K	K3-50K	K3-62K	K3-74K	K3-90K	K3-115K
Max. frequency of operations z	1/h	120	120	120	120	120	80	80	80
Contact life	non reactive capacitor banks S x 10 <sup>3</sup>	250	150	150	150	150	120	120	120
	reactive capacitor banks S x 10 <sup>3</sup>	400	300	300	300	300	200	200	200
Rated operational current I <sub>e</sub> AC6b	at 50°C A	0-18	14-28	14-36	30-48	30-72	30-108	50-115	50-144
	at 60°C A	0-18	14-28	14-36	30-48	30-72	30-87	50-108	50-130
Rated operational current I <sub>th</sub> AC1	at 50°C A	32	45	60	100	110	120	155	190
	at 60°C A	32	40	55	90	100	110	145	170
Overload factor acc. to EN 61921: 30% min.	at 50°C %	78	60	67	108	53	11	35	32
	at 60°C %	78	43	53	88	39	26	34	31
Fuses gL (gG)	from / to A	35 / 63	50 / 80	63 / 100	80 / 160	125 / 160	160/200	160/200	160/250



1) Coil voltage range and non-standard coil voltages see page 3  
 2) 1 HN.. or HA.. snap-on  
 3) 2HB.. for side mounting and 1 HN.. or HA.. snap-on  
 4) Consider the max. thermal current of the contactor K3-74A: I<sub>th</sub> 130A  
 5) 2 HB.. on the left or right side and 4 HN.. or HA.. snap-on  
 6) Consider the min. cross-section of conductor at max. load

## Contactors

for use with reactive capacitor banks

	Rated Operational Power at 50/60Hz Ambient Temperature						Aux. Contacts		Type	Coil Voltage 220-240V 50Hz	Pack pcs.	Weight kg/pc.
	50°C			60°C			Built-in	Add.				
	380V 400V kVA <sub>r</sub>	415V 440V kVA <sub>r</sub>	660V 690V kVA <sub>r</sub>	380V 400V kVA <sub>r</sub>	415V 440V kVA <sub>r</sub>	660V 690V kVA <sub>r</sub>	NO	NC	pcs.			
	<b>5</b>	5,5	8	<b>5</b>	5,5	8	1	-	4 <sup>1)</sup>	<b>K3-10A10</b> ...	1	0,23
	<b>9</b>	9,5	15	<b>9</b>	9,5	15	1	-	4 <sup>1)</sup>	<b>K3-14A10</b> ...	1	0,23
	<b>12,5</b>	13	20	12,5	13	20	1	-	4 <sup>1)</sup>	<b>K3-18A10</b> ...	1	0,23
	<b>13</b>	14	22	13	14	22	1	-	4 <sup>1)</sup>	<b>K3-22A10</b> ...	1	0,23
	<b>20</b>	22	33	20	22	33	-	-	6 <sup>2)</sup>	<b>K3-24A00</b> ...	1	0,48
	<b>25</b>	27	41	25	27	41	-	-	6 <sup>2)</sup>	<b>K3-32A00</b> ...	1	0,85
	<b>27,5</b>	30	48	27,5	30	48	-	-	6 <sup>2)</sup>	<b>K3-40A00</b> ...	1	0,85
	<b>33,3</b>	36	55	33,3	36	55	-	-	6 <sup>2)</sup>	<b>K3-50A00</b> ...	1	0,85
	<b>50</b>	53	82	50	53	82	-	-	6 <sup>2)</sup>	<b>K3-62A00</b> ...	1	0,85
	<b>75<sup>3)</sup></b>	75 <sup>3)</sup>	100	60	64	100	-	-	6 <sup>2)</sup>	<b>K3-74A00</b> ...	1	0,85
	<b>80</b>	82	120	75	77	120	-	-	9 <sup>4)</sup>	<b>K3-90A00</b> ...	1	2,2
	<b>100<sup>5)</sup></b>	103 <sup>5)</sup>	148 <sup>5)</sup>	90 <sup>5)</sup>	93 <sup>5)</sup>	148 <sup>5)</sup>	-	-	9 <sup>4)</sup>	<b>K3-115A00</b> ...	1	2,2

## Auxiliary Contact Blocks

	Rated Operational Current			Contacts	Type	Pack pcs.	Weight kg/pc.
	AC15		AC1				
	230V A	400V A	690V A				
	<b>6</b>	4	25	K3-10.. bis K3-115..	- 1	<b>HA01</b>	10 0,03
	<b>3</b>	2	10	K3-24.. bis K3-115..	1 1	<b>HB11</b>	10 0,02
	<b>3</b>	2	10	für seitlichen Anbau	- 2	<b>HB02</b>	10 0,02
	<b>3</b>	2	10	K3-18.. bis K3-115..	1 -	<b>HN10</b>	10 0,02
	<b>3</b>	2	10	K3-18.. bis K3-115..	- 1	<b>HN01</b>	10 0,02

## Coil Voltages and Voltage Ranges for capacitor switching contactors

Suffix to contactor type e.g. K3-18K10 24	for contactor-Type K3-10.. to K3-74..						Suffix to contactor type z.B.: K3-90K00 230	for contactor-Type K3-90.. to K3-115..					
	Voltage Marking		Rated Control Voltage U <sub>s</sub>					Voltage Marking		Rated Control Voltage U <sub>s</sub>			
	at the coil for 50Hz V	for 60Hz V	range for 50Hz min. max.	for 60Hz min. max.	for 50Hz min. max.	for 60Hz min. max.		at the coil for 50/60Hz V	for DC V	range for 50Hz min. max.	for 60Hz min. max.	for 50Hz min. max.	for 60Hz min. max.
24	24	24	22	24	24	27	24	24	22	24	22	24	
48	48	48	44	48	48	52	48	48	44	48	44	48	
110	110	110-120	100	110	110	122	110	110-120	110	110	120	110	120
180	180-210	200-240	180	210	200	240	200	200-220	200	200	220	200	220
<b>230</b>	<b>220-240</b>	<b>230-264</b>	<b>220</b>	<b>240</b>	<b>230</b>	<b>264</b>	<b>230</b>	<b>220-240</b>	<b>220</b>	<b>220</b>	<b>240</b>	<b>220</b>	<b>240</b>
400	380-415	400-440	380	415	400	460	400	380-415	-	380	415	380	415

1) 4 HN.. or HA.. snap-on

2) 2 HB.. on the left or right side and 4 HN.. or HA.. snap-on

3) Consider the max. thermal current: I<sub>th</sub> 130A

4) 2 HB.. on the left or right side and 7 HN.. or HA.. snap-on

5) Consider the min. cross-section of conductor at max. load

# Capacitor Switching Contactors

Data according to IEC 947-4-1, EN 60947-4-1, VDE 0660

Main Contacts	Type	K3-18K	K3-24K	K3-32K	K3-50K	K3-62K	K3-74K	K3-90K	K3-115K
<b>Utilization category AC6b</b>									
<b>Switching of non-reactive and reactive 3-phase capacitor banks</b>									
Ambient temperature ≤50°C									
Rated operational current I <sub>e</sub>	690V A	0-18	14-28	14-36	30-48	30-72	30-108 <sup>1)</sup>	50-115	50-144 <sup>2)</sup>
Rated operational power	220-240V kVAr	0-7	5-11	5-14	12-20	12-28	12-33	20-45	20-55 <sup>2)</sup>
	380-400V kVAr	0-12,5	10-20	10-25	20-33,3	20-50	20-75 <sup>1)</sup>	33-80	33-100 <sup>2)</sup>
	415-440V kVAr	0-13	10,5-22	10,5-27	23-36	23-53	23-75 <sup>1)</sup>	36-82	36-103 <sup>2)</sup>
	500V kVAr	0-15	12-25	12-30	26-40	26-60	26-75	43-100	43-120 <sup>2)</sup>
	525V kVAr	0-15	12-25	12-32	26-43	26-64	26-80	45-105	45-125 <sup>2)</sup>
	660-690V kVAr	0-20	17-33	17-41	36-55	36-82	36-120	57-120	57-148 <sup>2)</sup>
	1000V kVAr	-	-	-	-	-	-	85-160	85-200 <sup>2)</sup>
Ambient temperature ≤60°C									
Rated operational current I <sub>e</sub>	690V A	0-18	14-28	14-36	30-48	30-72	30-87	50-108	50-130 <sup>2)</sup>
Rated operational power	220-240V kVAr	0-7	5-11	5-14	12-20	12-28	12-30	20-40	20-50 <sup>2)</sup>
	380-400V kVAr	0-12,5	10-20	10-25	20-33,3	20-50	20-60	33-75	33-90 <sup>2)</sup>
	415-440V kVAr	0-13	10,5-22	10,5-27	23-36	23-53	23-64	36-77	36-93 <sup>2)</sup>
	500V kVAr	0-15	12-25	12-30	26-40	26-60	26-70	43-90	43-110 <sup>2)</sup>
	525V kVAr	0-15	12-25	12-32	26-43	26-64	26-75	45-95	45-115 <sup>2)</sup>
	660-690V kVAr	0-20	17-33	17-41	36-55	36-82	36-100	57-120	57-148 <sup>2)</sup>
	1000V kVAr	-	-	-	-	-	-	85-150	85-180 <sup>2)</sup>

# Contactors

Data according to IEC 947-4-1, EN 60947-4-1, VDE 0660



Main Contacts	Type	K3-10	K3-14	K3-18	K3-22	K3-24	K3-32	K3-40	K3-50	K3-62	K3-74	K3-90	K3-115
<b>Utilization category AC6b</b>													
<b>Switching of reactive capacitor banks</b>													
Ambient temperature ≤50°C													
Rated operational current I <sub>e</sub>	690V A	8	13	18	20	28	36	42	48	72	108 <sup>1)</sup>	115	144 <sup>2)</sup>
Rated operational power	220-240V kVAr	2,9	5	7	7,5	11	14	16	20	28	33	45	55 <sup>2)</sup>
	380-400V kVAr	5	9	12,5	13	20	25	27,5	33,3	50	75 <sup>1)</sup>	80	100 <sup>2)</sup>
	415-440V kVAr	5,5	9,5	13	14	22	27	30	36	53	75 <sup>1)</sup>	82	103 <sup>2)</sup>
	500V kVAr	6	11	15	17	25	30	36	40	60	75	100	125 <sup>2)</sup>
	525V kVAr	6	11	15	17	25	32	36	43	64	80	105	125 <sup>2)</sup>
	660-690V kVAr	8	15	20	22	33	41	48	55	82	120	120	148 <sup>2)</sup>
	1000V kVAr	-	-	-	-	-	-	-	-	-	-	160	200 <sup>2)</sup>
Ambient temperature ≤60°C													
Rated operational current I <sub>e</sub>	690V A	8	13	18	20	28	36	42	48	72	87	108	130 <sup>2)</sup>
Rated operational power	220-240V kVAr	2,9	5	7	7,5	11	14	16	20	28	30	40	50 <sup>2)</sup>
	380-400V kVAr	5	9	12,5	13	20	25	27,5	33,3	50	60	75	90 <sup>2)</sup>
	415-440V kVAr	5,5	9,5	13	14	22	27	30	36	53	64	77	93 <sup>2)</sup>
	500V kVAr	6	11	15	17	25	30	36	40	60	70	90	110 <sup>2)</sup>
	525V kVAr	6	11	15	17	25	32	36	43	64	75	95	115 <sup>2)</sup>
	660-690V kVAr	8	15	20	22	33	41	48	55	82	100	120	148 <sup>2)</sup>
	1000V kVAr	-	-	-	-	-	-	-	-	-	-	150	180 <sup>2)</sup>

1) Consider the max. thermal current: I<sub>th</sub> 130A

2) Consider the min. cross-section of conductor at max. load

# Contactors

## Data according to IEC 947-4-1, EN 60947-4-1, VDE 0660

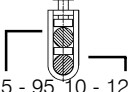
Main Contacts	Type	K3-10	K3-14	K3-18	K3-22	K3-24	K3-32	K3-40	K3-50	K3-62	K3-74	K3-90	K3-115	
<b>Rated insulation voltage</b> $U_i$ <sup>1)</sup>	V AC	690	690	690	690	690	690	690	690	690	690	1000	1000	
Rated operational current $I_e$ ( $=I_{th}$ ) at 40°C, open 690V	A	25	25	32	32	50	65	80	110	120	130	160	200	
<b>Maximum ambient temperature</b>														
Operation	open °C	-40 to +60 (+90) <sup>2)</sup>												
	enclosed °C	-40 to +40												
Storage	°C	-50 to +90												
<b>Short circuit protection</b>														
Coordination-type "1" acc. to IEC 947-4-1														
Contact welding without hazard of persons														
fuse size	from gL (gG) A	35	35	35	35	50	63	63	80	125	160	160	160	
	to gL (gG) A	63	63	63	63	80	100	100	160	160	200	200	250	
<b>Cable cross-sections</b>														
for contactors without thermal overload relay														
1 cable per clamp														
main connector	solid or stranded mm <sup>2</sup>	0,75 - 6				1,5 - 25			4 - 50			0,5 - 95		10 - 120
	flexible mm <sup>2</sup>	1 - 4				2,5 - 16			10 - 35			0,5 - 70		25 - 95
	flexible with multicore cable end mm <sup>2</sup>	0,75 - 4				1,5 - 16			6 - 35			0,5 - 70		10 - 95
2 cables per clamp														
	solid or stranded mm <sup>2</sup>	6+(1-6) / 4+(0,75-4)				16+(2,5-6) / 10+(4-10)			50+4 / 35+6 / 25+(6-16)			top 0,5-95		below 10-120
	flexible mm <sup>2</sup>	2,5+(0,75-2,5) / 1,5+(0,75-1,5)				6+(4-6) / 4+(2,5-4)			16+(6-16) / 10+(6-16)			0,5-70		10-95
	flexible mm <sup>2</sup>	6+(1,5-6) / 4+(1-4)				16+(2,5-6) / 10+(4-10)			50+(4-10) / 35+(4-16)			0,5-70		10-95
	flexible mm <sup>2</sup>	2,5+(0,75-2,5) / 1,5+(0,75-1,5)				6+(4-6) / 4+(2,5-4)			25+(4-25) / 16+(4-16)			0,5-70		10-95
Cables per clamp		2												
Screw / screw driver		M3,5 / Pz2				M5 / Pz2			M6 / Pz3			1+1		M8 / 4mm-inbus
Tightening torque	Nm/lb.inch	0,8-1,4 / 7-12				2,5-3 / 22-26			3,5-4,5 / 31-40			4-6,5 / 35-57		
for main connector	solid AWG	18 - 10				16 - 10			12 - 10			-		-
	flexible AWG	18 - 10				14 - 4			10 - 0			-		-
Cables per clamp		2				1			1			-		-
	solid AWG	10+(16-10) / 12+(18-12)				10+(16-10) / 12+(18-12)			10+(12-10) / 12+12			top 18-10		below -
	flexible AWG	14+(18-14) / 16+(18-16)				14+(18-14) / 16+(18-16)			1+(12-10) / 2+(8-12)			18-3/0		8-4/0
	flexible AWG	10+(14-10) / 12+(18-12)				4+(18-12) / 6+(18-8)			3+(12-8) / 4+(10-6)			1+1		
	flexible AWG	14+(18-14) / 16+(18-16)				8+(18-8) / 10+(18-12)								
Cables per clamp		2				2			2			1+1		
<b>Mechanical life</b>														
AC operated	S x 10 <sup>6</sup>	10				10			10			5		5
DC operated	S x 10 <sup>6</sup>	10				10			10			5		5
<b>Short time current</b>	10s-current A	96	120	144	176	184	240	296	360	504	592	680	880	
<b>Power loss</b>														
per pole	at $I_e$ /AC3 400V W	0,21	0,35	0,5	0,75	0,7	1,3	2	2,2	3,9	5,5	4,3	6,0	
<b>Auxiliary Contacts</b>														
<b>Rated insulation voltage</b> $U_i$ <sup>1)</sup>	V~	690				-			-			-		-
<b>Thermal rated current</b> $I_{th}$ to 690V														
Ambient temperature	40°C A	16				-			-			-		-
	60°C A	12				-			-			-		-
<b>Utilization category AC15</b>	220-240V A	12				-			-			-		-
Rated operational current $I_e$	380-415V A	4				-			-			-		-
	440V A	4				-			-			-		-
	500V A	3				-			-			-		-
	660-690V A	1				-			-			-		-
<b>Utilization category DC13</b>	60V A	8				-			-			-		-
Rated operational current $I_e$	110V A	1				-			-			-		-
	220V A	0,1				-			-			-		-
<b>Short circuit protection</b>														
short-circuit current 1kA, contact welding not accepted														
max. fuse size	gL (gG) A	25				-			-			-		-

1) Suitable at 690V for: earthed-neutral systems, overvoltage category I to IV, pollution degree 3 (standard-industry):  $U_{imp} = 8kV$ .

Data for other conditions on request.

2) With reduced control voltage range 0,9 up to  $1,0 \times U_s$  and with reduced rated current  $I_e$ /AC1 according to  $I_e$ /AC3

## Data according to IEC 947-4-1, EN 60947-4-1, VDE 0660

Type	K3-10	K3-14	K3-18	K3-22	K3-24	K3-32	K3-40	K3-50	K3-62	K3-74	K3-90	K3-115
<b>Control Circuit</b>												
<b>Power consumption of coils</b>												
AC operated	inrush VA	33-45				90-115			140-165		190-280	
	sealed VA	7-10				9-13			13-18		2,5-5	
	W	2,6-3				2,7-4			5,4-7		2,5-5	
DC operated	inrush W	75				140			200		190-280	
	sealed W	2				2			6		2,5-5	
<b>Operation range of coils</b>												
in multiples of control voltage $U_s$												
	AC operated	0,85-1,1				0,85-1,1			0,85-1,1		0,85-1,1	
	DC operated	0,8-1,1				0,8-1,1			0,8-1,1		0,8-1,1	
<b>Switching time</b>												
at control voltage $U_s \pm 10\%$ <sup>1) 2)</sup>												
AC operated	make time ms	8-16				10-25			12-28		20-35	
	release time ms	5-13				8-15			8-15		35-50	
	arc duration ms	10-15				10-15			10-15		10-15	
DC operated	make time ms	8-12				10-20			12-23		20-35	
	release time ms	8-13				10-15			10-18		35-50	
	arc duration ms	10-15				10-15			10-15		10-15	
<b>Cable cross-section</b>												
Auxiliary connector	solid mm <sup>2</sup>	0,75-6				-			-		-	
	flexible mm <sup>2</sup>	1-4				-			-		-	
	flexible with multicore cable end mm <sup>2</sup>	0,75-4				-			-		-	
Magnet coil	solid mm <sup>2</sup>	0,75-2,5				0,75-2,5			0,75-2,5		0,75-2,5	
	flexible mm <sup>2</sup>	0,5-2,5				0,5-2,5			0,5-2,5		0,5-2,5	
	flexible with multicore cable end mm <sup>2</sup>	0,5-1,5				0,5-1,5			0,5-1,5		0,5-1,5	
Clamps per pole		2				2			2		2	
Screw / screw driver		M3,5 / Pz2				M3,5 / Pz2			M3,5 / Pz2		M3,5 / Pz2	
Tightening torque	Nm/lb.inch	0,8-1,4 / 7-12				0,8-1,4 / 7-12			0,8-1,4 / 7-12		0,8-1,4 / 7-12	
Auxiliary connector	solid AWG	18 - 10-				-			-		-	
	flexible AWG	18 - 10				-			-		-	
Magnet coil	solid AWG	14 - 12				14 - 12			14 - 12		14 - 12	
	flexible AWG	18 - 12				18 - 12			18 - 12		18 - 12	
Clamps per pole		2				2			2		2	

## Capacitor Switching Contactors for North America

### Data according to UL508

Main Contacts (cULus)	Type	K3-18K	K3-24K	K3-32K	K3-50K	K3-62K	K3-74K	K3-90K	K3-115K
Rated operational power of 3-phase capacitor banks at 60Hz (3ph)	110-120V kVAr	0-3,5	3-5,5	3-7	6,5-10	6,5-15	6,5-18 <sup>3)</sup>	10-24	10-28 <sup>4)</sup>
	200V kVAr	0-6	4,5-10	4,5-12,5	10-16,7	10-25	10-32 <sup>3)</sup>	17-40	17-46 <sup>4)</sup>
	220-240V kVAr	0-7	5,5-11	5,5-15	12,5-20	12,5-30	12,5-36 <sup>3)</sup>	20-47	20-56 <sup>4)</sup>
	440-480V kVAr	0-15	11,5-25	11,5-30	25-40	25-60	25-72 <sup>3)</sup>	40-95	40-114 <sup>4)</sup>
	550-600V kVAr	0-18	14,5-30	14,5-35	31-50	31-75	31-90 <sup>3)</sup>	50-120	50-143 <sup>4)</sup>
Fuse Class RK5 / Short-circuit current	A/kA	50/5	90/5	125/5	200/5	250/5	300/5	300/10	300/10
Fuse Class T / Short-circuit current	A/kA	70/100	110/100	150/100	175/100	175/100	175/100	300/100 <sup>5)</sup>	300/100 <sup>5)</sup>
Rated voltage	V	600	600	600	600	600	600	600	600
<b>Auxiliary Contacts (cULus)</b>		A600	-	-	-	-	-	-	-

1) Total breaking time = release time + arc duration

2) Values for delay of the release time of the make contact and the make time of the break contact will be increased, if magnet coils are protected against voltage peaks (varistor, RC-unit, diode-unit)

3) Consider the max. thermal current of the contactor K3-74A:  $I_m$  130A

4) Consider the min. cross-section of conductor at max. load

5) Class T and Class RK1

# Contactors

## Dimensions

Capacitor switching contactors, AC operated

K3-18K..

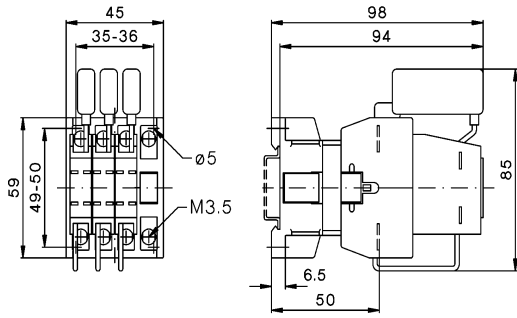

Contactors AC-operated

K3-10A10  
K3-14A10  
K3-18A10  
K3-22A10

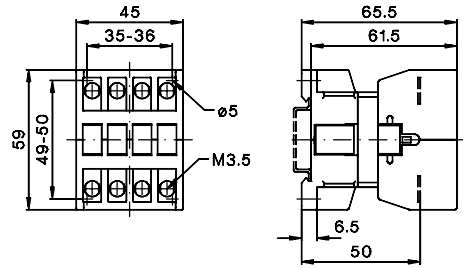

K3-24K00  
K3-32K00

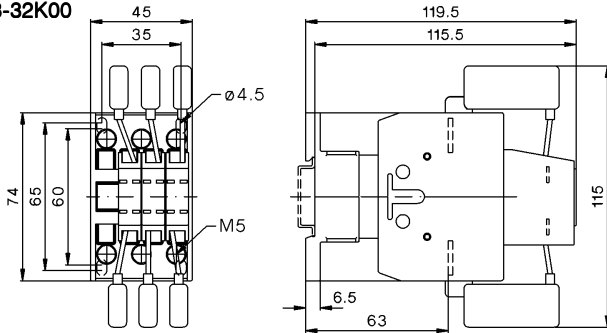

K3-24A00  
K3-32A00  
K3-40A00

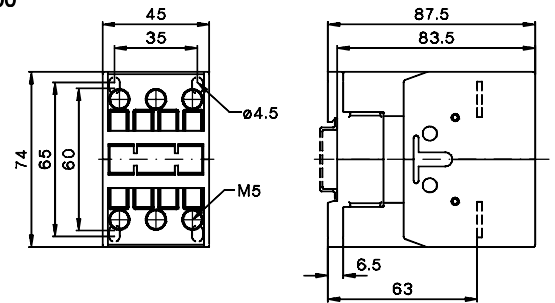

K3-50K00  
K3-62K00  
K3-74K00

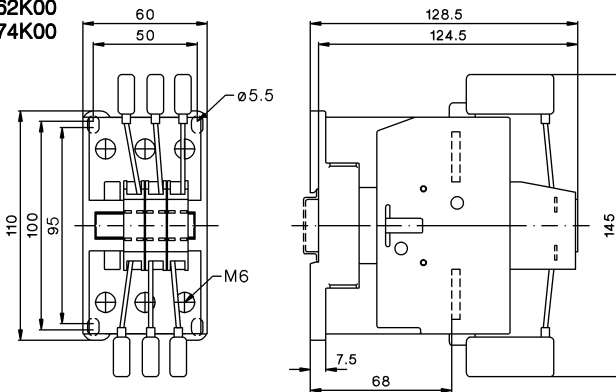

K3-50A00  
K3-62A00  
K3-74A00

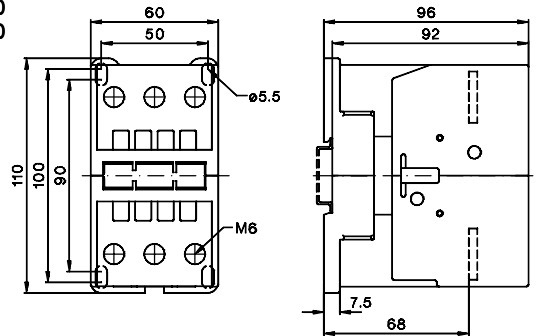

K3-90K00  
K3-115K00

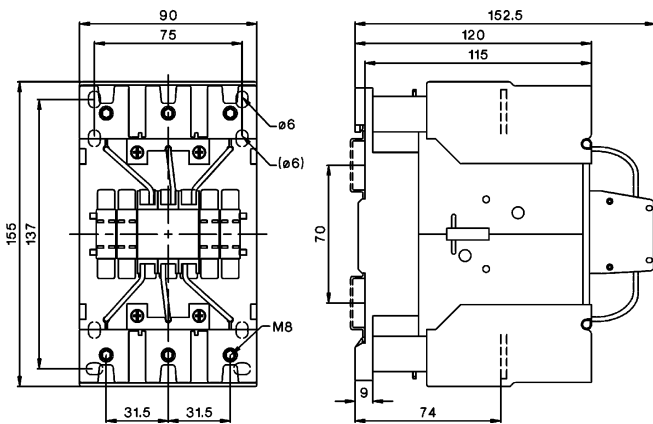

K3-90A00  
K3-115A00

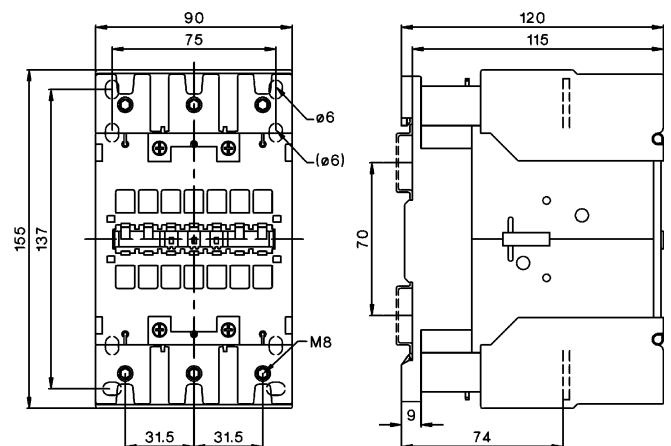

## Typical Circuit Diagram of Capacitor Switching Contactors

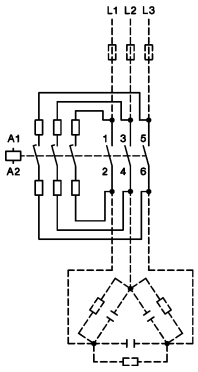

Typical Circuit Diagram

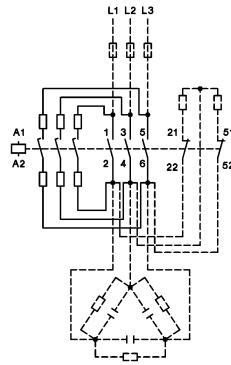

**Wiring Diagram for Quick Discharge Resistors**

Make sure that the current of the discharge resistors is not higher than the rated current (AC1) of the auxiliary contacts

## Contactor operation at direct switching of capacitors

### Theoretic view of function

#### Make

In case of the pre-contacts during make, the current peaks are attenuate by resistor wires. These current peaks would weld the main-contacts of contactor and they are also not good for the capacitors.

The total resistance of the resistor wires is mostly ohmic, the inductive one can be ignored. The looking like a coil is only a case of construction.

The single controlled pre-contacts are increasing the safety of operating, in opposite of contamination during operation.

#### Operation:

During operation the resistor wires are not getting warmer, because they are not in the circuit.

#### Break:

Important: these contactors can be used for both installations, because the pre-contacts have no function during break, thus means that the peaks of the break-over voltage (power) of the chokes can't make any damage.



## Description

### Function diagram

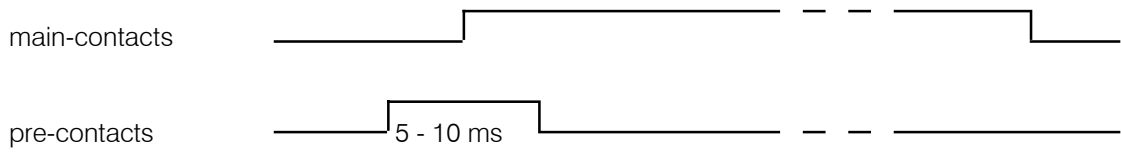

### Practical function - oscillogram

make with pre-contacts (B&J\Oszi11)

K3-18K 12.5kVAr (18A / 400V)

vertical: **250A** / div horizontal: 1ms / div

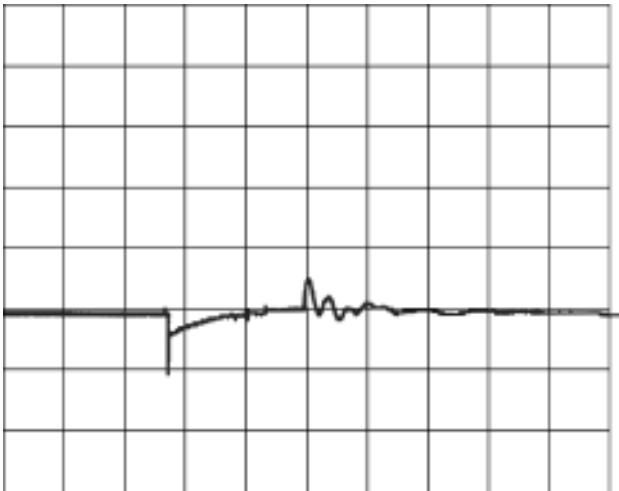

Description:

The difference of the diagrams is the current scale only.

First current peak due to make of pre-contacts.

Second current peak due to building-up the main-circuit with notable lower amplitude as the first and not so steep, that means lower frequency.

make with pre-contacts (B&J\Oszi10)

K3-18K 12.5kVAr (18A / 400V)

vertical: **100A** / div horizontal: 1ms / div

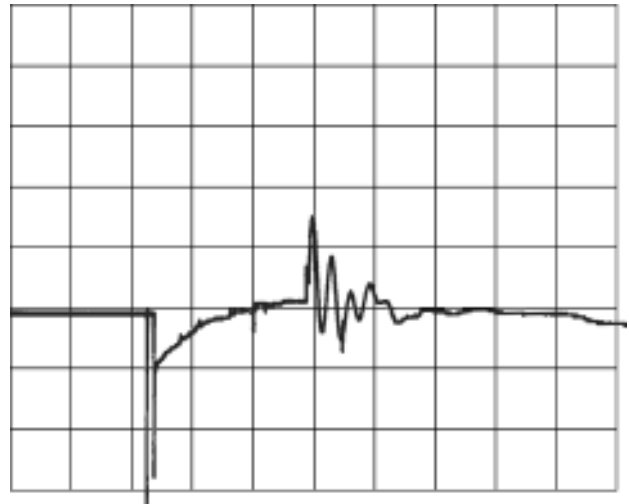

## Description

make **with** pre-contacts (B&J\Oszi13)

K3-18K 12.5kVAr (18A / 400V)

vertical: 250A / div horizontal: 0.5ms / div

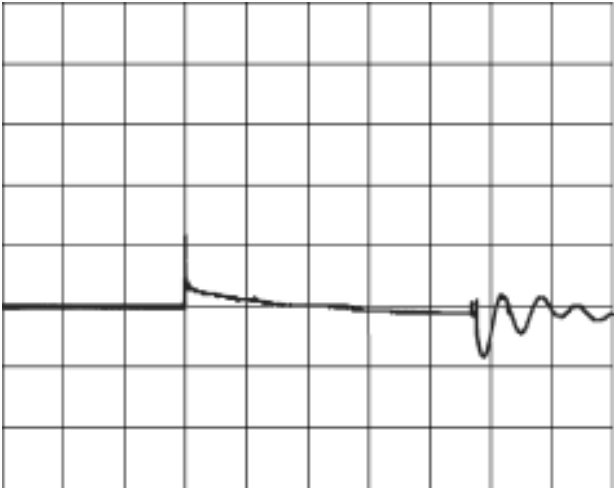

make **without** pre-contacts (B&J\Oszi12)

K3-18A 12.5kVAr (18A / 400V)

vertical: 250A / div horizontal: 0.5ms / div

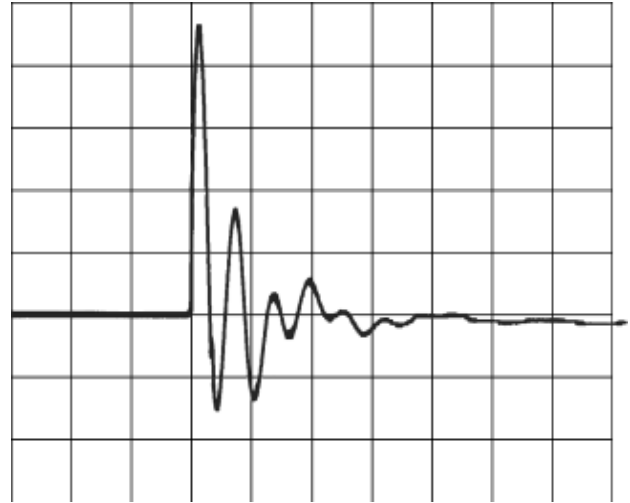

The right picture shows a make current peak without pre-contacts with about 1200A with high power in opposite to 280A with low power (power = integrated area).

Of course, the contactors endure a few switches without pre-contacts.

## Switching of capacitor banks at different conditions

make **without** pre-contacts (B&J\Oszi16)  
**without** chokes

K3-62A 50kVAr (72A / 690V)

vertical: **2000A** / div horizontal: 0.625ms / div

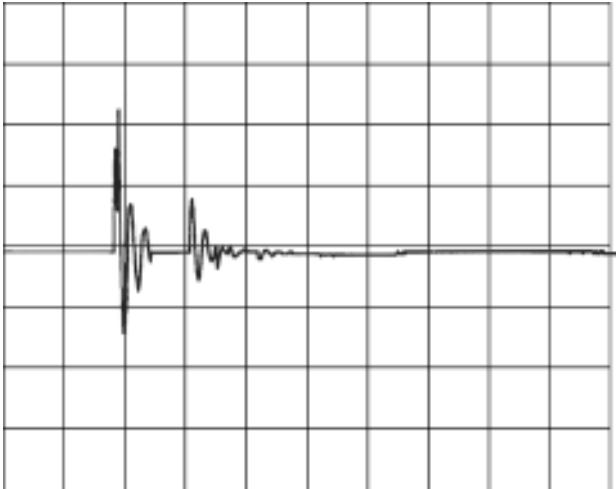

make **without** pre-contacts (B&J\Oszi15)  
**with** chokes

K3-62A 50kVAr (72A / 690V)

vertical: **200A** / div horizontal: 10ms / div

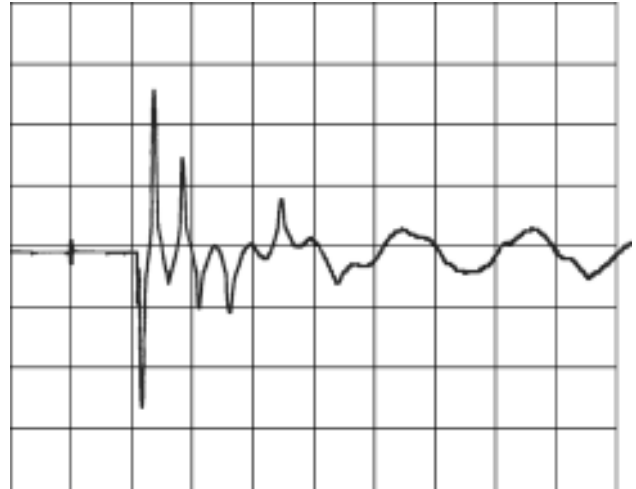

make **with** pre-contacts (B&J\Oszi14)  
**with** chokes

K3-62K 50kVAr (72A / 690V)

vertical: **200A** / div horizontal: 10ms / div

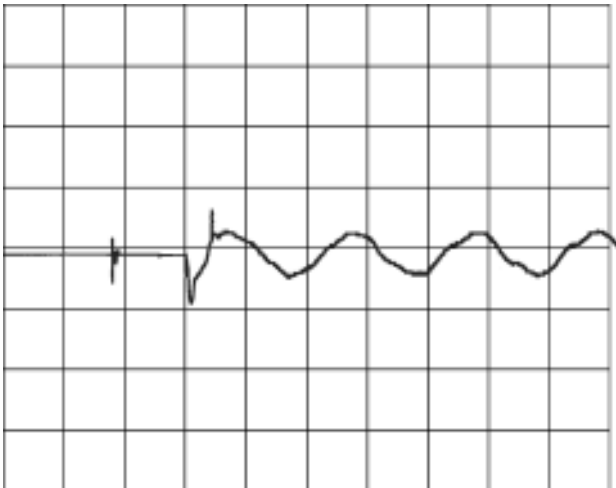

The make current peak without pre-contacts and without chokes is higher than 4000A.

This peak can be reduced by the influence of chokes to approx. 500A.

In the last case we see the influence of chokes and pre-contacts of the "capacitor contactor". The peak is reduced to approx. 200A.

Also the sinus-wave is very clear by the influence of chokes because you have reduced harmonic frequencies.

Notice: